

AZOR-V







Desaguadora 3 motores - REF : MD3M

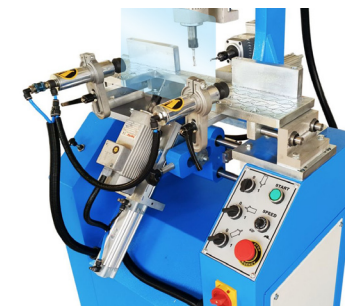
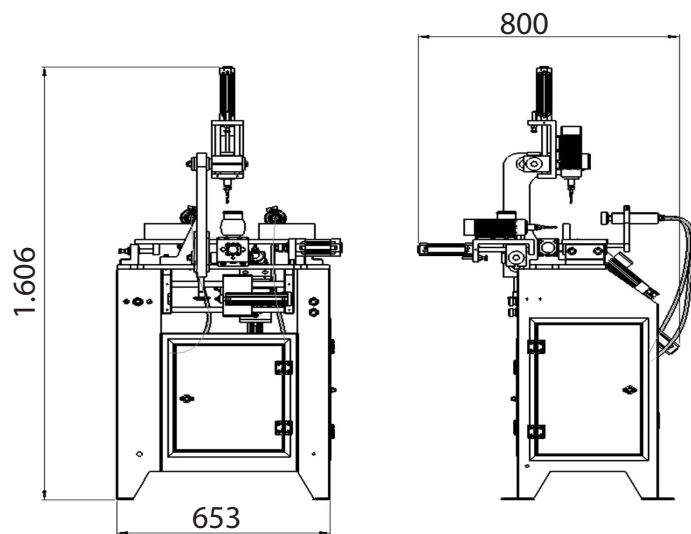

CARACTERÍSTICAS

- » El procedimiento de apertura de los canales de drenaje comienza con el sistema de accionamiento neumático.
- » Con tres ejes para abrir canales de drenaje en los perfiles de PVC.
- » Fácil ajuste de ranurado de diferentes tipos y perfiles.
- » Seguridad total contra accidentes laborales.
- » Selección de motor con pulsadores.
- » Motores de velocidad regulable.
- » sistema de PLC.

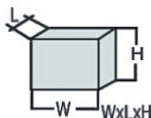

Características técnicas							
	0.55 KW 230V 50Hz	0.55 KW 230V 50Hz	0.55 KW 230V 50Hz	14000 d/RPM	BAR 6-8 Bar	Hava tüke. Air cons. 5 Lt/dak. Lt/min.	WxLxH 68x80x140 cm
							90 kg